



**ANSCHÜTZ**

EINFACH EINS WERDEN!

MODEL

**1761**

THE NEW **SYNTHESIS**  
OF **HIGH TECHNOLOGY**  
AND **CRAFTSMANSHIP**



Since 1856, over the course of six generations, we have paired available knowledge with newly-obtained scientific understanding. We generate **trust**, we generate **reliability**, we generate **precision**. All of this, so you can stand up proudly and say:

**“MY ANSCHÜTZ”**



1761

## THE FIRST SHOT

You pick it up, and at once you feel:

***This small-bore rifle is something else!***

At this moment, you probably won't think immediately about the gunsmith in his studio and about the time spent in **polishing metal components**; maybe you don't know anything about the care with which the technician **lapped** and **honed** the barrel, but the matte surface, the perfectly soft gliding head of the bolt, and the **closed** connection of the stock and framework formed by the hidden thrust bearing will captivate you.

You will likely not even feel the small bearing, the four millimetres of steel support in the interior of the bolt, in which the three-lug locking mechanism ensures a self-centring closure in the action, but you will certainly notice the smooth repeating speed of the 1761.

***The way you become one with the 1761 will trigger a smile: My rifle!***

***You won't want to put it down.***

## 1761 THUMBHOLE STOCK

### THE COMPLEX MADE SIMPLE – PRECISION IN PERFECTION

The thumbhole stock. The eye-catcher when it comes to optical and functional advantages. Light walnut, oiled with satin finish; the trigger finger is free to act without being burdened. The milled recesses lend the 1761 in the thumbhole stock a futuristic look, which will maintain its good appearance for many years to come!



- 1 Non-slip rubber butt pad
- 2 Ergonomic walnut thumbhole stock, oiled with satin finish
- 3 Integrated groove for optic recoil lug
- 4 Silent positive safety
- 5 11 mm-ANSCHÜTZ prism rail
- 6 Interchangeable ANSCHÜTZ precision barrel
- 7 Recessed muzzle
- 8 Classic ambidextrous walnut stock, right-handed version, lacquered left-handed version, oiled with satin finish
- 9 Non-slip checkering in new design
- 10 Detachable 5-shot magazine, easy to exchange
- 11 Magazine release lever
- 12 Trigger guard made of high strength molded polymer
- 13 Single stage trigger 5061 D Heavy, 400 g - 1.200 g
- 14 Studs

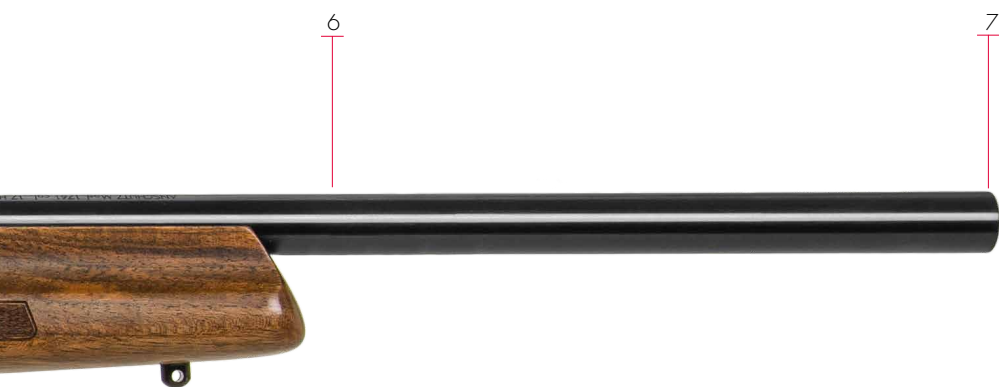

## 1761 CLASSIC

### **WELL-BALANCED**

The well balanced and ambidextrous lacquered walnut stock. Looks traditional – looks good. For the right-handed shooter, for the left-handed shooter. Straight-forward, effective, low in vibration, well-balanced. Laser-cut, weather-resistant checkering for optimal grip. Shock-absorbing, non-slip butt pad.



## 1761 WHISPER – ONLY AVAILABLE IN .22 l.r

### SILENT TRUST

Whispering, quiet and silent. Stainless steel, accuracy craftsmanship, easy handling. Radiate silence, convinces all along the line. With low noise, highest precision and with little damage to the game or pelt, this rifle is well suited for urban areas.



- 1 Non-slip rubber butt pad
- 2 Classic ambidextrous walnut stock, lacquered
- 3 Integrated groove for optic recoil lug
- 4 Silent positive safety
- 5 11mm-ANSCHÜTZ prism rail
- 6 Integrated sound moderator
- 7 Studs
- 8 Single stage trigger 5061 D Heavy, 400g - 1.200g

- 9 Trigger guard made of high strength molded polymer
- 10 Magazine release lever
- 11 Detachable 5-shot magazine, easy to exchange
- 12 Non-slip checkering in new design
- 13 Rear sight with three inlaid yellow luminous dots
- 14 Red pearl front sight out of polymer with protection hood, adjustable in height
- 15 Recessed muzzle with inner thread M12x1





Model 1761 Whisper. Caliber .22 l.r.,  
Classic stock, integrated sound moderator  
Best.-Nr.: 015279 (Right-handed)

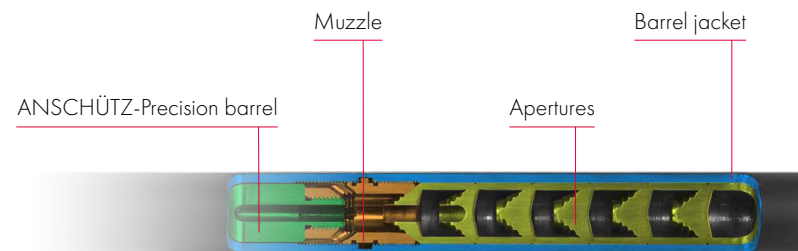

Inner construction of the integrated  
sound moderator at model 1761 Whisper



Thread adapter for  
Model 1761 FL Classic,  
From inner thread M12x1 to  
outer thread 1/2" - 20 UNF

## 1761 FL CLASSIC (OPEN SIGHT) RAPID TARGET PICK-UP WITH HIGH CONTRAST

The high-contrast open sight only covers a small area and permits a rapid target pick-up. Ideal for a quick shots at close range without a scope. The rear sight with three inlaid yellow luminous dots can be adjusted laterally and in height. The red pearl front sight is covered by a protection hood and provides a good contrast - also in low light conditions.



## 1761 MP R MULTI PURPOSE BEAVERTAIL **FLEXIBLE FOR HIGHEST PRECISION**

Developed from the needs of shooters from the range and the field, this stock combines the advantages of a classic target stock, combined with the wide and easy to handle beavertail forend. The integrated aluminum rail in the forend makes this stock a great overall package. Stained walnut with stippled checkering at pistol grip, prepared for attaching a butt plate carrier.



3  
9

- 1 Non-slip rubber butt pad
- 2 Prepared for attaching a butt plate carrier
- 3 Stained Multi Purpose Beavertail stock
- 4 Integrated groove for optic recoil lug
- 5 Silent positive safety
- 6 11 mm-ANSCHÜTZ prism rail
- 7 Interchangeable ANSCHÜTZ precision barrel
- 8 Reinforced, recessed muzzle with groove for attaching a front sight
- 9 Stippled checkering

- 10 Wide and easy to handle beavertail forend with integrated aluminum rail for accessories
- 11 Match two stage trigger 5061 Light, 250g - 400g
- 12 Trigger guard made of high strength molded polymer
- 13 Magazine release lever
- 14 Detachable 5-shot magazine, easy to exchange
- 15 Grip and forend with stippled checkering and integrated aluminum rail for accessories





Reinforced, recessed muzzle with groove for attaching a front sight.



## 1761 MS R SILHOUETTE **THE SILHOUETTE RIFLE**

The ANSCHÜTZ smallbore rifle for shooting on metal silhouettes and targets. Receiver with an 11 mm ANSCHÜTZ prism rail and grooved barrel for attaching a front sight, so you can also shoot with sight set. Anatomically designed stock with cheek piece especially made for these disciplines. With non-slip and adjustable rubber butt plate and aluminum rail in the forend. The stock is prepared for the assembly of a butt plate carrier – to adjust the stock in length. Stippled checkering on pistol grip and forend.



FROM HERE TO THERE.

**RELIABLE. DISTRACTION FREE. 1761**



1761

## **FIND REPOSE**

Shooting is a complex, contradictory act, but ultimately, in the core of its being, it forces the shooter to re-examine himself.

LOOK INWARD – BREATHE – STAY STILL – FEEL – CONCENTRATE ... the actual triggering of the shot is almost of secondary importance.

On the following pages, you will experience the 1761 in its full range of detail. You will see the interplay of cleverly devised components produced with devotion and tested with meticulous attention to detail

**The ANSCHÜTZ 1761.**

## 1761 RECEIVER

# WHAT TURNS YOU ON. EVERYTHING THAT MAKES A ANSCHÜTZ.

The foundation of our high precision rests on the barreled action design. Geometry inspired by our target rifles, with a high degree of stiffness, a flat supporting surface and an integrated recoil lug. The precision action is manufactured by highly demanding production processes and with gunsmiths expertise. In the action integrated well engineered ejector can be changed very easily. The luminous matte surface lends the model 1761 a timeless appearance, which will continue to look excellent even for many years to come.



## 1761 BOLT RUNS EASY AND QUICK

The small bearing reduces the force needed to open and to close the bolt. Fast and easy repeats are possible. Symmetrically arranged three-lug locking mechanism for the highest safety and phenomenal precision. Simple disassembly for care and cleaning. The high-quality and resistant QPQ coating ensures additional sliding capacity, resistance to wear, and corrosion protection, and thus is perfect for use in hunting and for harsh weather conditions.

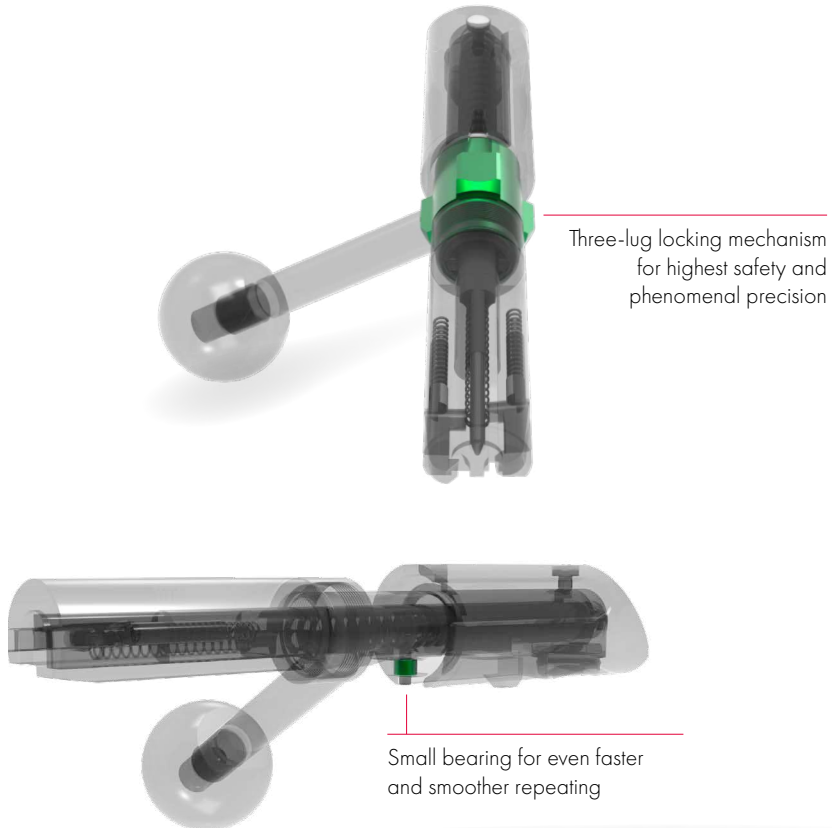

## 1761 TRIGGER OUR TRADITION

It doesn't matter which kind of trigger you need, whether single stage or two stage, which aiming position is preferred or required, whether prone, sitting, kneeling or freehand standing:

With four different triggers for the model 1761, you will find the perfect interface between you and your 1761 smallbore rifle.

**There is nothing better.**

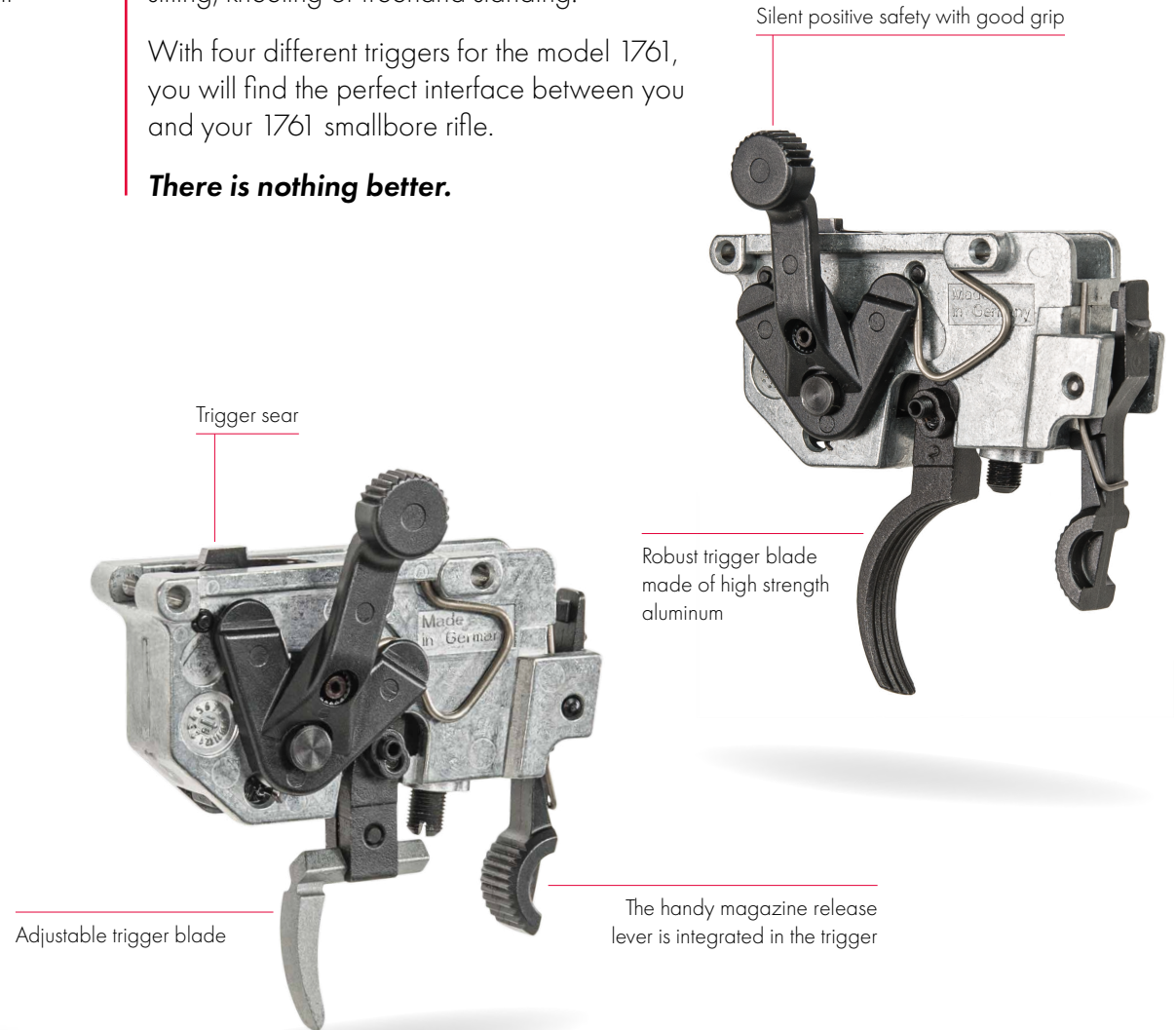

## 1761 BARREL VERSIONS

### EXPERIENCE LEADS TO PRECISION

The 1761 modular system offers the perfect barrel versions for every application. If you need a heavy precision barrel or classic hunting barrels in different lengths - we have what you looking for.

#### Following barrel versions for your perfect configuration:

- Heavy precision barrel, grooved, with reinforced muzzle
- Two different muzzle threads  
1/2" - 20 UNF and 1/2" - 28 UNEF
- Precision hunting barrels in different lengths  
20.3" (515 mm) without barrel thread  
20.3" (515 mm) with barrel thread  
18" (457 mm) with barrel thread  
14" (356 mm) with barrel thread
- Hunting barrel with open sight  
20.3" (515 mm) with inner thread M12x1
- Barrel with integrated sound moderator (only .22 l.r.)  
19.3" (492 mm). The integrated sound moderator is easy to disassemble and to clean

If you would like to change the caliber, the barrel can be easily altered by a qualified gunsmith. Thanks to its two tenon locking clamps, the barrel clamping allows for the barrel to be re-inserted with perfect precision - every time.



## 1761 OPTICS & MOUNTS

### THE LINK

Simple telescopic sight mounting with the help of the 11-mm ANSCHÜTZ action prism rail. Integrated recoil lug in the prism rail ensures the highest stability of the mount. Optional 1761 picatinny rail available for mounting various optics.



## 1761 MAGAZINE

### STRONG HANDLING

The single-stack 5-shot magazine with a robust stainless steel housing can be changed extremely quick and easy. This is made possible by the release lever integrated into the trigger and the extended magazine base plate.

The high-strength magazine base plate is made of weather-resistant polymer.



ANSCHÜTZ

EINFACH EINS. WERDEN!

TRADITION

THAT MEANS IN CONSISTENCY AND STEADFASTNESS IN  
UPHOLDING THE CONCEPT OF „**MADE IN GERMANY**”

Rudolf Anschütz (left)  
with plant manager  
Hermann Wild (right) at  
the development in 1950.

## 1761 STOCK AND ACTION BEDDING THE BASE OF PRECISION

The lacquered Classic hunting stock with its straight comb is suitable for right-handed as well as left-handed shooters (ambidextrous). The non-slip checkering in new design ensures a sure and stable grip even in rain. The ergonomically designed thumbhole stock made of oiled walnut with satin finish ensures stability in the firing position and a relaxed shooting posture thanks to its roll-over cheek piece and its sharp pistol grip.

The MP R Multi Purpose Beavertail stock, as well as the MS R Silhouette stock are equipped with a stippled checkering. Furthermore, these two stocks are the bridge between the needs of the shooting range and the hunting grounds. The aluminum rail in the forend enables the attachment of accessories, such as a hand stop. These stocks are also prepared for the assembly of a but plate carrier.

The solid and flat bedding of the barreled action in the stock ensures the highest precision. Just phenomal details.

Integrated aluminum rail



Integrated recoil lug

Solid and flat bedding



ANSCHÜTZ

EINFACH EINS WERDEN

PRODUCED WITH DEVOTION

**TESTED WITH CARE**

# 1761 MODULAR SYSTEM

## YOUR 1761 FOR HUNTING USE

### 1. CHOOSE VERSION

Right-handed



Left-handed



Single-stack 5-shot detachable magazine

### 2. CHOOSE A BARREL VERSION

#### Barrel without thread

Length of barreled action .....637 mm  
 Barrel length .....20.3" (515 mm)  
 Muzzle diameter ..... 19 mm



#### Barrel with thread and thread protector

Length of barreled action .....637 mm  
 Barrel length .....20.3" (515 mm)  
 Muzzle diameter ..... 19 mm



- 1/2"-20 UNF
- 1/2"-28 UNEF

#### Barrel with thread and thread protector

Length of barreled action .....579 mm  
 Barrel length ..... 18" (457 mm)  
 Muzzle diameter ..... 19 mm



- 1/2"-20 UNF
- 1/2"-28 UNEF

#### Barrel with thread and thread protector

Length of barreled action .....478 mm  
 Barrel length ..... 14" (356 mm)  
 Muzzle diameter ..... 19 mm



- 1/2"-20 UNF
- 1/2"-28 UNEF

#### Barrel with open sight (FL) and inner thread M12x1

Length of barreled action .....637 mm  
 Barrel length .....20.3" (515 mm)  
 Muzzle diameter ..... 19 mm



### 3. CHOOSE A CALIBER

#### Caliber .17 MACH 2

Number of grooves .....6  
 Twist rate .....228 mm



#### Caliber .17 HMR

Number of grooves .....6  
 Twist rate .....228 mm



#### Caliber .22 I.r.

Number of grooves .....8  
 Twist rate .....420 mm



#### Caliber .22 WMR

Number of grooves .....4  
 Twist rate .....400 mm



### 4. CHOOSE A TRIGGER

#### Single stage trigger 5061 D Light

Adjusted to .....300 g  
 Range of adjustment .....250 g - 450 g

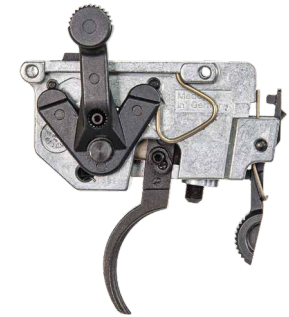

#### Single stage trigger 5061 D Heavy

Adjusted to .....1.000 g  
 Range of adjustment .....400 g - 1.200 g

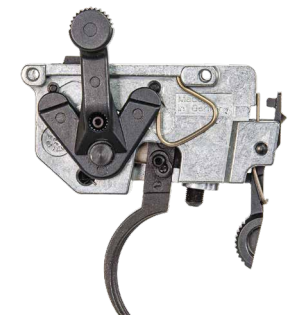

## 5. CHOOSE A STOCK – RIGHT HANDED VERSION

### Two stage trigger 5061 Light

Adjusted to .....300 g  
Range of adjustment .....250 g - 450 g

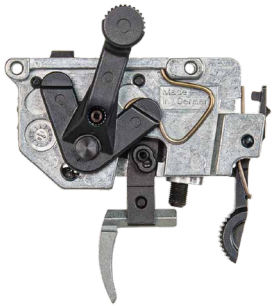

### Classic stock, lacquered

Length of pull .....360 mm  
Length of stock .....745 mm  
Material.....Walnut with checkering  
Butt plate .....Rubber butt pad  
Accessories.....Studs and trigger guard



### Thumbhole stock, oiled with satin finish

Length of pull .....360 mm  
Length of stock .....745 mm  
Material.....Walnut with checkering  
Butt plate .....Rubber butt pad  
Accessories.....Studs and trigger guard



## CHOOSE A STOCK – LEFT HANDED VERSION

### Two stage trigger 5061 Heavy

Adjusted to .....1.000 g  
Range of adjustment .....400 g - 1.200 g

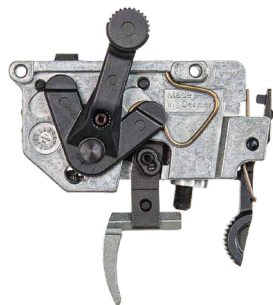

### Classic stock, oiled with satin finish

Length of pull .....360 mm  
Length of stock .....745 mm  
Material.....Walnuss with checkering  
Butt plate .....Rubber butt pad  
Accessories.....Studs and trigger guard



# YOUR 1761 FOR THE RANGE AND THE FIELD

## 1. CHOOSE A BARRELED ACTION

### Caliber .22 I.r.

Number of grooves .....8

Twist rate.....420mm



### Right-handed version

Single-stack 5-shot detachable magazine.



### Barreled action with heavy grooved barrel

Total length.....637 mm

Barrel length.....21.4" (544 mm)

Muzzle diameter.....22 mm



### Barrel without thread

Length of barreled action .....637 mm

Barrel length.....20.3" (515 mm)

Muzzle diameter.....19 mm



### Barrel with thread and thread protector

Length of barreled action .....637 mm

Barrel length.....20.3" (515 mm)

Muzzle diameter.....19 mm



 1/2"-20 UNF

 1/2"-28 UNEF

### Barrel with thread and thread protector

Length of barreled action .....579 mm

Barrel length.....18" (457 mm)

Muzzle diameter.....19 mm



 1/2"-20 UNF

 1/2"-28 UNEF

### Barrel action with open sight (FL) and inner thread M12x1

Length of barreled action .....637 mm

Barrel length.....20.3" (515 mm)

Muzzle diameter.....19 mm



## 2. CHOOSE A TRIGGER

### Single stage trigger 5061 D Light

Adjusted to.....300 g

Range of adjustment .....250 g - 450 g

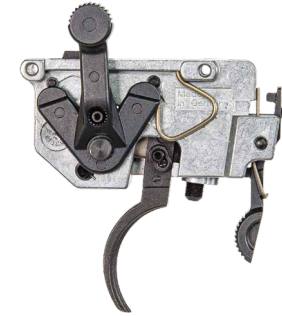

+

### Single stage trigger 5061 D Heavy

Adjusted to.....1.000 g

Range of adjustment .....400 g - 1.200 g



**Two stage trigger 5061 Light**

Adjusted to .....300 g  
Range of adjustment .....250 g - 450 g

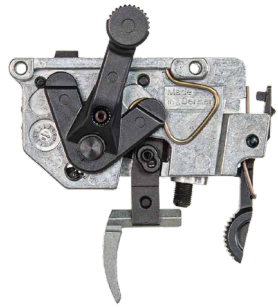

**Two stage trigger 5061 Heavy**

Adjusted to .....1.000 g  
Range of adjustment .....400 g - 1.200 g

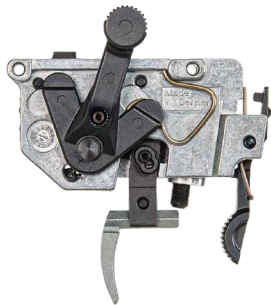

**3. CHOOSE A STOCK**

**MP R Multi Purpose Beavertail, stained**

Length of pull .....360 mm  
Length of stock .....760 mm  
Material.....Hardwood incl.  
stippled checkering

Butt plate .....Rubber butt pad, adjustable  
Accessories.....Trigger guard and aluminum rail  
Specials.....Prepared for attaching a butt plate carrier



Aluminum rail for attaching accessories like a hand stop

**MS R Silhouette, lacquered**

Length of pull .....330 mm  
Length of stock .....780 mm  
Material.....Walnut incl.  
stippled checkering

Butt plate .....Rubber butt pad, adjustable  
Accessories.....Trigger guard and aluminum rail  
Specials.....Prepared for attaching a butt plate carrier



Aluminum rail for attaching accessories like a hand stop



ANSCHÜTZ JOINS TOGETHER

**NOT JUST IN DESIGNING RIFLES**

# 1761 ACCESSORIES FOR THE FINISHING TOUCH



**1761 Picatinny rail,**  
for scope mounts, red-dots  
or sights



**1761 5-shot magazine,**  
replacement

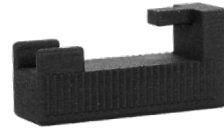

**1761 Magazine loading help,**  
enables easy and quick loading  
of the magazine



**Thread adapter,**  
from inner thread 1/2 inch – 20 UNF  
to outer thread 1/2 inch – 28 UNEF.



**1761 Barrels ,**  
In the offered calibers  
and versions



**Bipod made out of aluminum,**  
adjustable in length  
and foldable



**1761 Trigger guard,**  
made out of aluminum



**Sound moderator,**  
for caliber .22 l.r.



**Thread adapter for  
Model 1761 FL Classic,**  
from inner thread M12x1 to  
outer thread 1/2" - 20 UNF



**Sight set 6834,**  
rear sight 6805, front sight CENTRA incl.  
aperture clamping screw and transparent  
aperture



**Sling swivels, 1"**  
Optimum solution for a fast  
exchange and removal of  
gun slings



**Aluminum butt plate,**  
for mounting on 1761 MP R and MS R  
stocks. So the stock can be adjusted in  
length.



**Bolt knob,**  
made out of steel, Ø 25 mm



**ANSCHÜTZ Special soft case for hunting and sporting rifles,**  
as a special feature, the new carrying strap system, including a lock,  
also lets you carry the soft case on your back.

## 1761 TECHNICAL SPECIFICATIONS

# CONFIGURATIONS AND DETAILS

Depending on the selected configuration, the technical specifications of your model 1761 will be different.

The total weight is between approx. 2.500 - 4.000g

The total length is between approx. 740 - 970 mm

### CONFIGURATION EXAMPLES

#### Model 1761, 20.3" (515 mm) barrel in classic stock

Total length..... 960 mm

Total weight, approx. .... 2.890 g

#### Model 1761, 18" (457 mm) barrel in thumbhole stock

Total length..... 902 mm

Total weight, approx. .... 2.930 g

#### Model 1761, 21.4" (544 mm) barrel in MP R stock

Total length..... 970 mm

Total weight, approx. .... 3.500 g

#### Model 1761 21.4" (544 mm) barrel in MS R stock

Total length..... 950 mm

Total weight, approx. .... 4.000 g

#### Model 1761 Whisper, 19.3" (492 mm) integrated sound moderator in classic stock

Total length..... 935 mm

Total weight, approx. .... 3.150 g

### CALIBER

**Caliber** ..... **.17 MACH 2**

Number of grooves ..... 6

Twist rate..... 228 mm

**Caliber** ..... **.17 HMR**

Number of grooves ..... 6

Twist rate..... 228 mm

**Caliber** ..... **.22 I.r.**

Number of grooves ..... 8

Twist rate..... 420 mm

**Caliber** ..... **.22 WMR**

Number of grooves ..... 4

Twist rate..... 400 mm

### MAGAZINE

**For Calibers –**

**.17 MACH 2 | .17 HMR**

**.22 I.r. | .22 WMR**

Capacity ..... 5-shots

Weight..... 100 g

Material..... Stainless steel

### TRIGGER

**Model**..... **5061 D Light**

Kind of trigger ..... Single stage trigger

Adjusted to ..... 300 g

Range of adjustment ..... 250 - 450 g

Weight..... 115 g

**Model**..... **5061 D Heavy**

Kind of trigger ..... Single stage trigger

Adjusted to ..... 1.000 g

Range of adjustment ..... 400 - 1.200 g

Weight..... 115 g

**Model**..... **5061 Light**

Kind of trigger ..... Two stage trigger

Adjusted to ..... 300 g

Range of adjustment ..... 250 - 450 g

Weight..... 115 g

**Model**..... **5061 Heavy**

Kind of trigger ..... Two stage trigger

Adjusted to ..... 1.000 g

Range of adjustment ..... 400 - 1.200 g

Weight..... 115 g

## BARRELED ACTION

### Version ..... without thread

Total length..... 637 mm  
 Barrel length ..... 20.3" (515 mm)  
 Muzzle diameter ..... 19 mm  
 Weight..... 1.965 g

### Version ..... 20.3" with thread

Total length..... 637 mm  
 Barrel length ..... 20.3" (515 mm)  
 Barrel thread ..... 1/2" - 20 UNF / 1/2" - 28 UNEF  
 Muzzle diameter ..... 19 mm  
 Weight..... 1.965 g

### Version ..... 18" with thread

Total length..... 579 mm  
 Barrel length ..... 18" (457 mm)  
 Barrel thread ..... 1/2" - 20 UNF / 1/2" - 28 UNEF  
 Muzzle diameter ..... 19 mm  
 Weight..... 1.840 g

### Version ..... 14" with thread

Total length..... 481 mm  
 Barrel length ..... 14" (356 mm)  
 Barrel thread ..... 1/2" - 20 UNF / 1/2" - 28 UNEF  
 Muzzle diameter ..... 19 mm  
 Weight..... 1.550 g

### Version ..... with grooved havy barrel

Total length..... 666 mm  
 Barrel length ..... 21.4" (544 mm)  
 Muzzle diameter ..... 22 mm  
 Weight..... 2.150 g

### Version ..... with integrated sound moderator

Total length..... 615 mm  
 Barrel length ..... 14" (356 mm)  
 Integrallauflänge ..... 19,3" (492 mm)  
 Barrel thread ..... 1/2" - 20 UNF  
 Muzzle diameter ..... 25 mm  
 Weight..... 1.900 g

### Version ..... with open sight

Total length..... 637 mm  
 Barrel length ..... 20.3" (515 mm)  
 Barrel thread ..... M12x1 Inner thread  
 Muzzle diameter ..... 19 mm  
 Weight..... 1.950 g

## STOCK

### Version ..... Classic stock

Total length of stock ..... 745 mm  
 Length of pull ..... 360 mm  
 Weight, approx. .... 928 g  
 Finish..... lacquered  
 Butt plate ..... Rubber butt pad

### Version ..... Thumbhole stock

Gesamte Schaftlänge .... 745 mm  
 Length of pull ..... 360 mm  
 Weight, approx. .... 1.090 g  
 Finish..... oiled, satin finish  
 Butt plate ..... Rubber butt pad

### Version ..... MP R Beavertail

Gesamte Schaftlänge .... 760 mm  
 Length of pull ..... 360 mm  
 Weight, approx. .... 1.500 g  
 Finish..... stained  
 Butt plate ..... Rubber butt pad

### Version ..... MS R Silhouette

Gesamte Schaftlänge .... 780 mm  
 Length of pull ..... 330 mm  
 Weight, approx. .... 1.900 g  
 Finish..... lacquered  
 Butt plate ..... Rubber butt pad

## 1761 FOR THE HUNT CONFIGURATION

SELECTABLE COMPONENTS – FOR THE HUNT			Selection
VERSION	Right-handed	<input type="checkbox"/>	
	Left-handed	<input type="checkbox"/>	
BARREL AND THREAD	20.3" Barrel (515 mm) with recessed muzzle	<input type="checkbox"/>	
	20.3" Barrel (515 mm) with thread and thread protector	<input type="checkbox"/>	
	18" Barrel (457 mm) with thread and thread protector	<input type="checkbox"/>	
	14" Barrel (356 mm) with thread and thread protector	<input type="checkbox"/>	
	20.3" Barrel (515 mm) with open sight (FL) and inner thread M12x1	<input type="checkbox"/>	
	Barrel thread 1/2"-20 UNF	<input type="checkbox"/>	
	Barrel thread 1/2"-28 UNEF	<input type="checkbox"/>	
CALIBER	.17 MACH 2	<input type="checkbox"/>	
	.17 HMR	<input type="checkbox"/>	
	.22 l.r.	<input type="checkbox"/>	
	.22 WMR	<input type="checkbox"/>	
TRIGGER	Single stage trigger 5061 D Light, adjusted to 300 g, adjustable from 250 g - 450 g	<input type="checkbox"/>	
	Single stage trigger 5061 D Heavy, adjusted to 1.000 g, adjustable from 400 g - 1.200 g	<input type="checkbox"/>	
	Two stage trigger 5061 Light, adjusted to 300 g, adjustable from 250 g - 450 g	<input type="checkbox"/>	
	Two stage trigger 5061 Heavy, adjusted to 1.000 g, adjustable from 400 g - 1.200 g	<input type="checkbox"/>	
STOCK	Classic stock, lacquered (Classic stock for left hand version, oiled)	<input type="checkbox"/>	
	Thumbhole stock, oiled with satin finish	<input type="checkbox"/>	

## 1761 FOR THE RANGE AND FIELD CONFIGURATION

SELECTABLE COMPONENTS – FOR THE RANGE AND FIELD			Selection
VERSION	Right-handed, Caliber .22 l.r.	<input type="checkbox"/>	
BARREL AND THREAD	20.3" Barrel (515 mm) with recessed muzzle	<input type="checkbox"/>	
	20.3" Barrel (515 mm) with thread and thread protector	<input type="checkbox"/>	
	18" Barrel (457 mm) with thread and thread protector	<input type="checkbox"/>	
	21.4" Heavy barrel (544 mm) grooved with recessed muzzle	<input type="checkbox"/>	
	20.3" Barrel (515 mm) with open sight (FL) and inner thread M12x1	<input type="checkbox"/>	
	Barrel thread 1/2"-20 UNF	<input type="checkbox"/>	
	Barrel thread 1/2"-28 UNEF	<input type="checkbox"/>	
TRIGGER	Single stage trigger 5061 D Light, adjusted to 300 g, adjustable from 250 g - 450 g	<input type="checkbox"/>	
	Single stage trigger 5061 D Heavy, adjusted to 1.000 g, adjustable from 400 g - 1.200 g	<input type="checkbox"/>	
	Two stage trigger 5061 Light, adjusted to 300 g, adjustable from 250 g - 450 g	<input type="checkbox"/>	
	Two stage trigger 5061 Heavy, adjusted to 1.000 g, adjustable from 400 g - 1.200 g	<input type="checkbox"/>	
STOCK	MP R stock, stained	<input type="checkbox"/>	
	MS R stock, lacquered	<input type="checkbox"/>	

# 1761 COMPLETE MODELS

## NOT CONFIGURABLE

SELECTABLE CONFIGURATION		Item No.:	Selection
MODELS	1761 Whisper, Caliber .22 l.r., Single stage trigger 5061 D Heavy, Classic stock	015279	

# 1761

## ACCESSORIES



SELECTABLE COMPONENTS		Selection
RECOMMENDED ACCESSORIES	Picatinny rail	<input type="checkbox"/>
	Magazine 5-shot, replacement	<input type="checkbox"/>
	Magazine loading help	<input type="checkbox"/>
	Thread adapter from 1/2"-20 UNF to 1/2"-28 UNEF	<input type="checkbox"/>
	Barrel 20.3" (515 mm) each caliber	<input type="checkbox"/>
	Barrel 20.3" (515 mm) with thread, each caliber	<input type="checkbox"/>
	Barrel 18" (457 mm) with thread, each caliber	<input type="checkbox"/>
	Barrel 14" (356 mm) with thread, each caliber	<input type="checkbox"/>
	Barrel 21.4" (544 mm), caliber .22 l.r.	<input type="checkbox"/>
	Wood class Premium, each stock	<input type="checkbox"/>
	Wood class Luxus, each stock	<input type="checkbox"/>
	Wood class Meistergrade, each stock	<input type="checkbox"/>
	Bipod made out of aluminum	<input type="checkbox"/>
	Trigger guard made out of aluminum	<input type="checkbox"/>
	Sound moderator for caliber .22 l.r.	<input type="checkbox"/>
	Thread adapter for Model 1761 FL Classic	<input type="checkbox"/>
	Sight set 6834, rear sight 6805 front sight CENTRA M18	<input type="checkbox"/>
Sling swivels, 1"	<input type="checkbox"/>	
Aluminum butt plate COMFORT	<input type="checkbox"/>	
Bolt knob Ø 25 mm made out of steel	<input type="checkbox"/>	
Special soft case for hunting and sporting rifles	<input type="checkbox"/>	
Robust transport rifle case	<input type="checkbox"/>	

# ANSCHÜTZ

EINFACH EINS WERDEN!

## J.G. ANSCHÜTZ GmbH & Co. KG Jagd- und Sportwaffenfabrik

Daimlerstraße 12 · 89079 Ulm / Germany

Fon +49 - (0)731 - 40 12 - 0

Fax +49 - (0)731 - 40 12 - 700

[www.anschuetz-sport.com](http://www.anschuetz-sport.com)

[www.facebook.com/OfficialAnschuetz](https://www.facebook.com/OfficialAnschuetz)

[www.youtube.com/AnschuetzGmbH](https://www.youtube.com/AnschuetzGmbH)

[www.instagram.com/AnschuetzGmbH](https://www.instagram.com/AnschuetzGmbH)

Your dealer

“ANSCHÜTZ researches and produces on a high level of technology. In our creations, we draw on the never outdated source of traditional craftsmanship.

In the end, tradition means consistency and steadfastness, not losing your head when it comes to the multitude of perhaps tempting but short-lived trends. And so, we see ourselves as the guardians of an excellent “Made in Germany” concept:

We manufacture nearly all the components of our rifles by ourselves. The employees of ANSCHÜTZ are aware of the responsibility bound up in each individual step of production and are proud to bring with them their experience and specialist knowledge. This is the foundation of the first-class quality of ANSCHÜTZ!

ANSCHÜTZ rifles are not just simple production firearms. They are individual masterpieces that are designed, assembled and tested with the utmost attention to detail.”



**Jochen Anschütz**

President

